

## Peak Emission Wavelength: 1550nm

The MTSM5415SMR2 is a 1550nm SWIR Emitter in a Seam Welded Surface Mount package for applications requiring high output power and efficiency.

### FEATURES

- > 5mm x 5mm Seam Welded Surface Mount Package
- > High Reliability
- > High Output Power
- > Hermetically Sealed Package

### APPLICATIONS

- > Bio Medical Applications
- > Optical Sensors
- > Aerospace
- > Industrial Controls

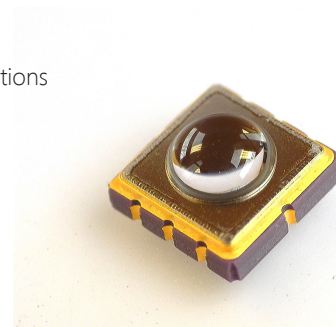

## Absolute Maximum Ratings (Ta=25°C)



ITEMS	SYMBOL	RATINGS	UNIT
Forward Current (DC)	IF	100	mA
Forward Current (Pulse)*1	IFP	1	A
Reverse Voltage	VR	5	V
Power Dissipation	PD	100	mW
Operating Temperature Range	Topr	-20 ~ +85	°C
Storage Temperature Range	Tstg	-30 ~ +100	°C

\*1: Tw=10μsec, T=10msec

## Electrical & Optical Characteristics (Ta = 25°C)

ITEMS	SYMBOL	CONDITIONS	MIN	TYP	MAX	UNIT
Forward Voltage	VF	IF=50mA	--	0.84	--	V
Power Output	PO	IF=50mA	--	3.8	--	mW
Reverse Current	IR	VR=5V	--	--	10	μA
Peak Emission Wavelength	λp	IF=50mA	--	1550	--	nm
Spectral Line Half Width	Δλ	IF=50mA	--	90	--	nm
Half Intensity Beam Angle	Θ	IF=50mA	--	40	--	deg

Package Dimensions

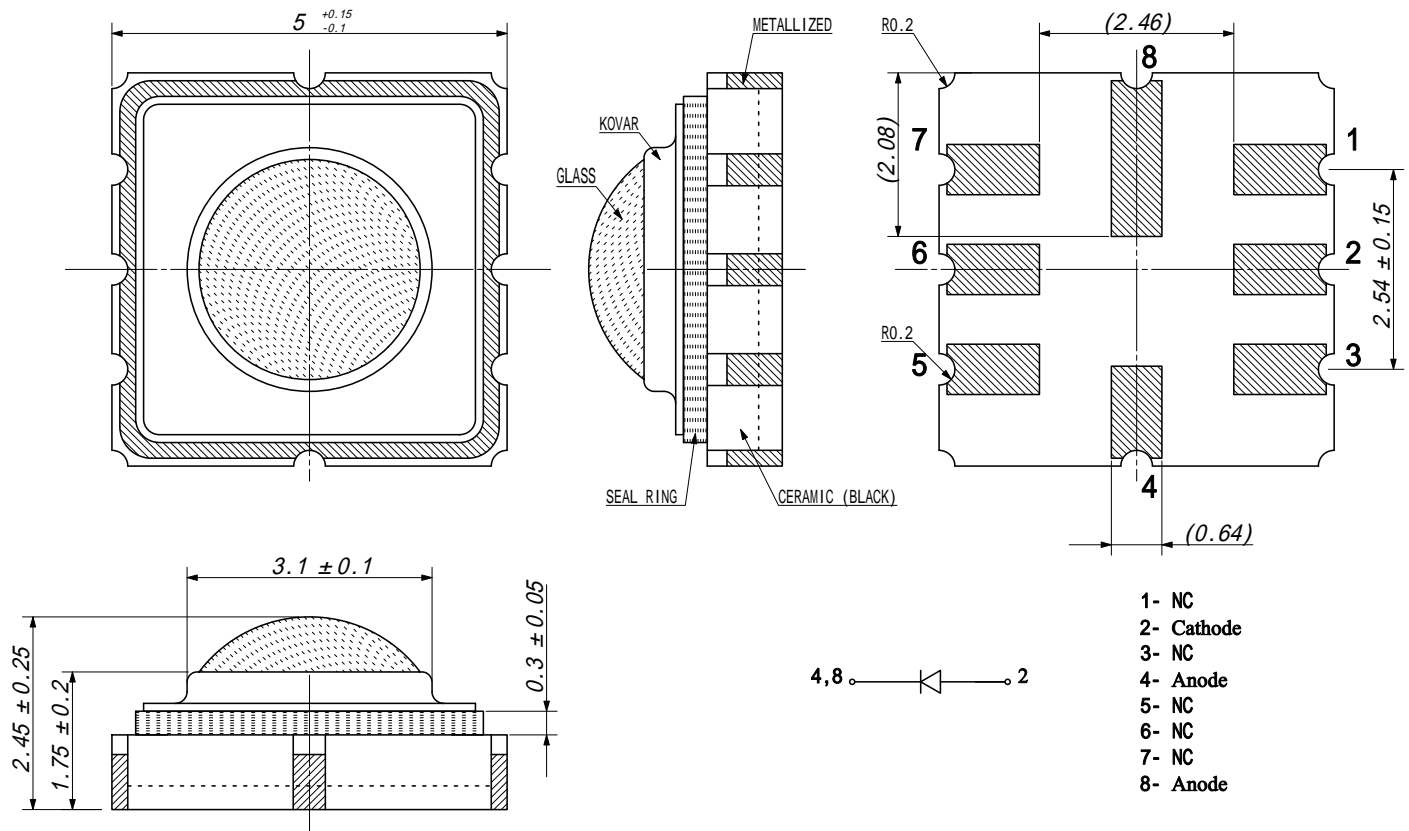

Recommended Soldering Pattern [mm]

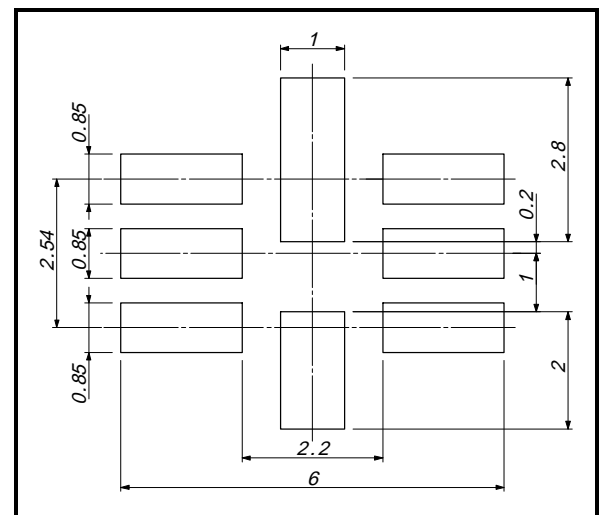

Reflow Soldering Temperature-Profile [Pb free Soldering] (Recommend condition)

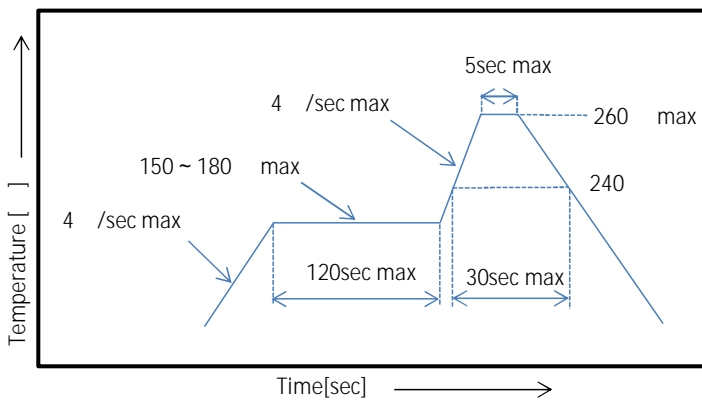

**SPECTRAL RESPONSE**

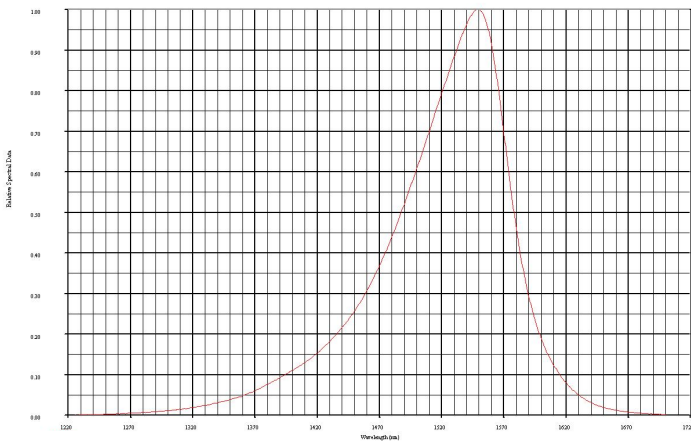

**RADIATION DISTRIBUTION**

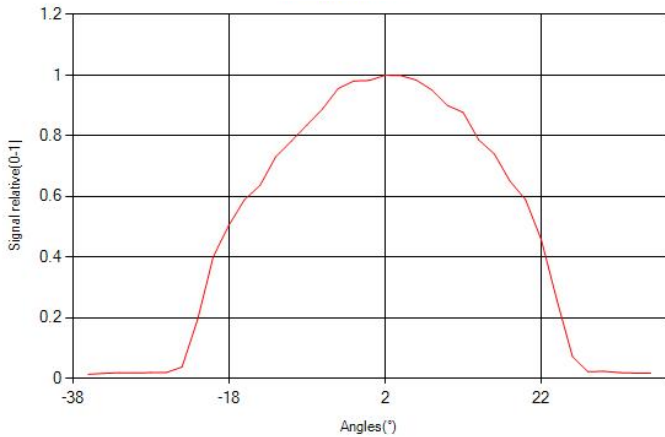

**VIEW ANGLE**

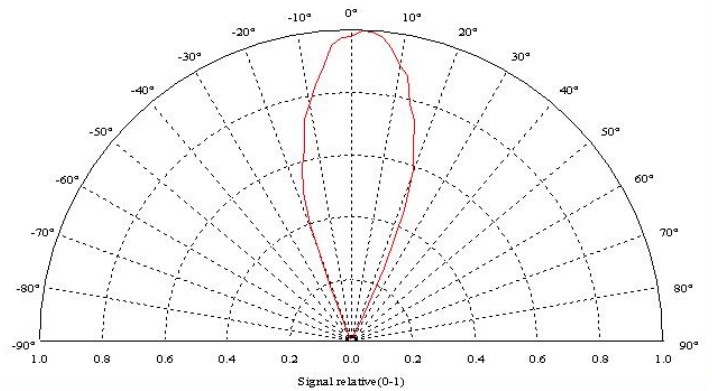

The information contained herein is subject to change without notice.

2023-11-06